

shackles



Alloy Steel Shackles

US Fed Spec RR-C-271 / EN13889

Bow and Dee

with Screw pin or Safety pin

factor of safety 6:1

WLL	D	D1	A	C Dee	C Bow	E	D2	Weight Screw	Weight Safety
[t]	[mm]	[mm]	[mm]	[mm]	[mm]	[mm]	[mm]	[kgs]	[kgs]
0.33	5	6	10	19	22	16	13	0.02	-
0.50	6	8	12	25	29	20	16	0.05	0.06
0.75	8	10	13	27	32	21	20	0.10	0.11
1.00	9	11	16	31	36	26	22	0.14	0.15
1.50	11	13	18	37	43	29	26	0.19	0.21
2.00	13	16	22	43	47	33	34	0.36	0.40
3.25	16	19	27	51	60	42	40	0.63	0.70
4.75	19	22	31	59	71	51	47	1.10	1.10
6.50	22	25	36	73	84	58	53	1.50	1.70
8.50	25	28	43	85	95	68	60	2.20	2.50
9.50	28	32	47	90	108	74	67	3.10	3.40
12.00	32	35	51	94	119	83	74	4.30	4.50
13.50	35	38	57	115	132	89	80	5.50	6.10
17.00	38	42	60	127	146	98	89	7.40	7.60
25.00	45	50	74	149	178	126	104	13.00	13.00
35.00	50	57	83	171	197	138	119	18.00	18.00
55.00	65	70	105	20.	260	180	145	38.00	35.00
85.00	75	83	127	229	330	190	163	62.0	56.0

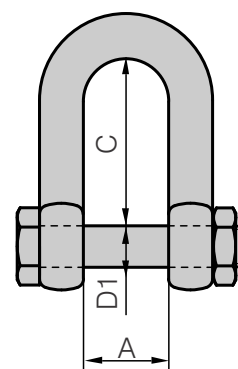
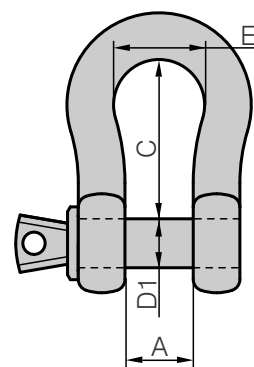
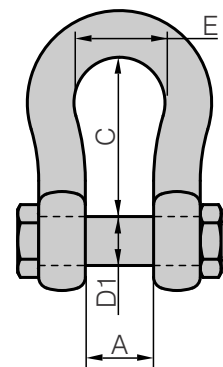

Bow - H10 type

with Safety pin

factor of safety 5:1

WLL	D	D1	A	C	D2	E	Weight Safety
[t]	[mm]	[mm]	[mm]	[mm]	[mm]	[mm]	[kgs]
120	89	95	150	380	200	238	110
150	102	108	170	400	230	275	160
200	120	125	180	500	260	290	235
250	125	140	205	540	260	305	285
300	130	150	205	600	305	570	340
400	165	175	230	680	350	325	560
500	180	185	255	700	370	350	685
600	195	205	285	700	405	375	880
700	205	217	310	700	435	400	980
800	210	217	310	700	435	400	1100
900	220	230	330	700	465	420	1280
1000	230	240	350	750	480	420	1460
1250	278	270	370	780	590	450	2320
1500	280	290	370	800	610	450	2450

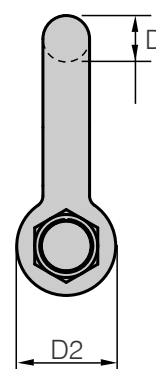
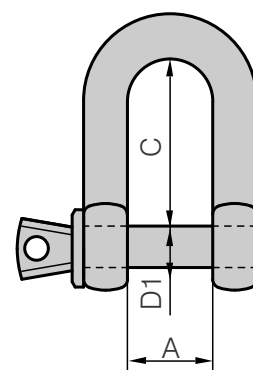

Reduction of Work Load Limits

Work load limits on shackles are subject to downward adjustment in case of side loading

45° reduce to 70% of WLL

90° reduce to 50% of WLL

If extreme temperature conditions are applicable

0 - 200° 1.00 x WLL

201 - 300° 0.90 x WLL

301 - 400° 0.75 x WLL

above 400° do not use

Markings

All tested shackles come standard with the following markings:

1. work load limit in tonnes
2. manufacturer's mark
3. grade of steel
4. CE mark
5. batch mark
6. body diameter

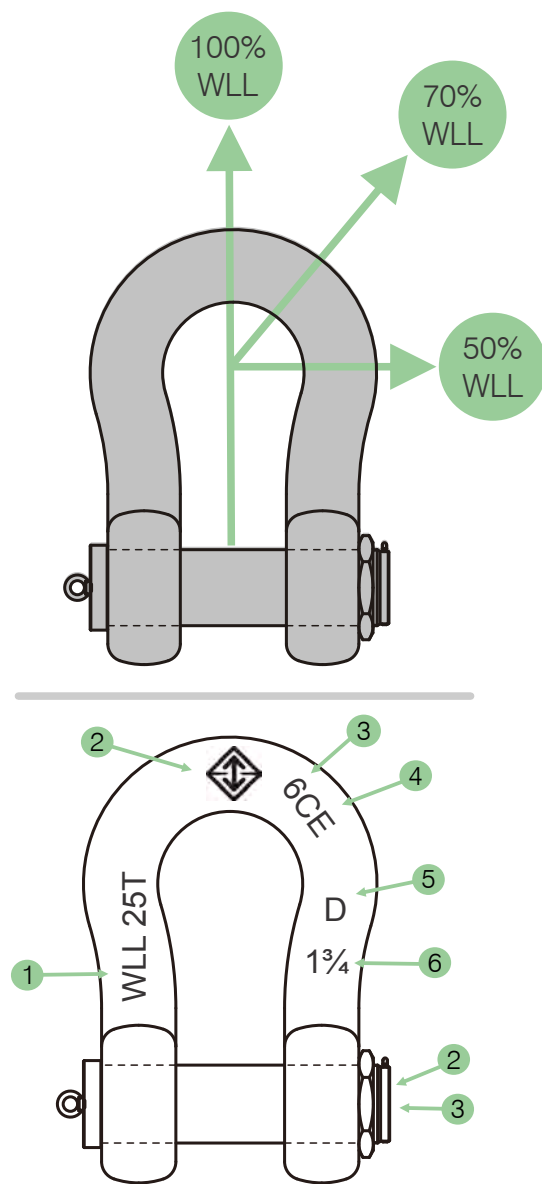

Pin types

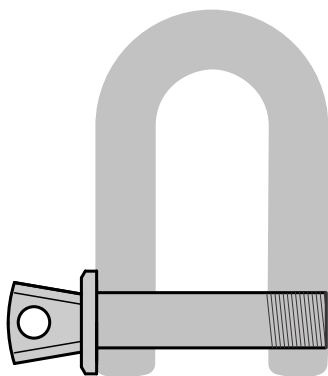

screw pin

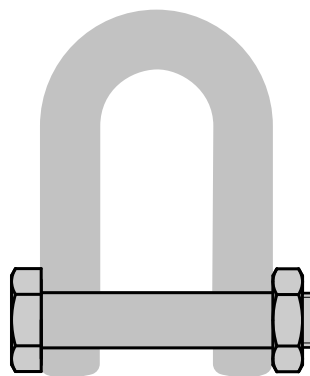

safety pin

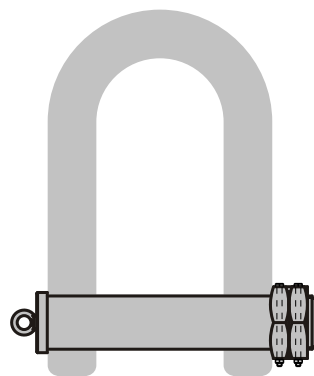

double nut pin

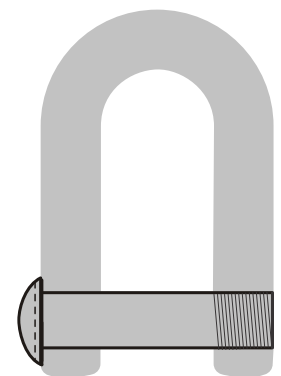

counter sunk pin



Dee - H11 type

with Heavy duty double nut pin

factor of safety 5:1

WLL	MBL	Thimble size	A	B	C	D	E	L	Weight
[t]	[t]	[inch]	[mm]	[mm]	[mm]	[mm]	[mm]	[mm]	[kgs]
34	170	8.5-10	50	65	140	285	115	345	23
60	300	11-13	70	76	160	360	165	430	59
85	425	14-15	80	90	220	390	178	505	85
110	550	16-18	90	100	254	430	210	575	122
130	650	19-21	100	114	290	480	235	620	170
200	1000	19-21	125	133	300	600	265	695	282
225	1125	22-24	130	146	333	720	305	735	349

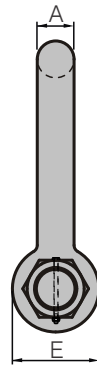
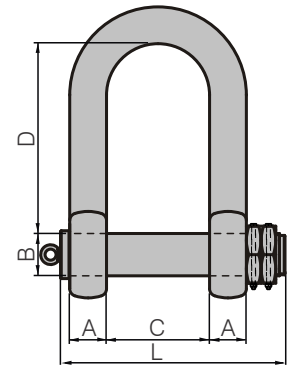

Sling protector (wide body) - H14 type

with Safety pin

factor of safety 5:1

WLL	A	B	C	D	E	F	G	R	Weight
[t]	[mm]	[mm]	[mm]	[mm]	[mm]	[mm]	[mm]	[kgs]	[kgs]
40	45	50	73	210	140	95	105	50	16
55	60	56	90	240	160	115	116	60	31
75	70	70	105	290	185	120	135	70	45
125	80	80	130	365	220	150	152	80	120
150	90	95	140	390	250	170	185	90	160
200	105	105	150	480	275	205	225	110	230
250	110	120	170	550	300	240	240	130	320
300	140	134	185	600	350	265	280	140	340
400	160	160	220	600	370	320	330	170	620
500	170	180	250	650	450	340	350	180	800
600	180	200	275	720	490	370	405	190	960
700	200	215	300	750	540	400	465	210	1250
800	220	230	325	780	555	420	465	210	1400
900	238	250	350	850	585	440	480	220	2100
1000	240	270	380	850	615	460	530	230	2200
1250	260	300	430	930	645	530	570	270	2800
1500	280	320	460	950	680	560	610	290	3300

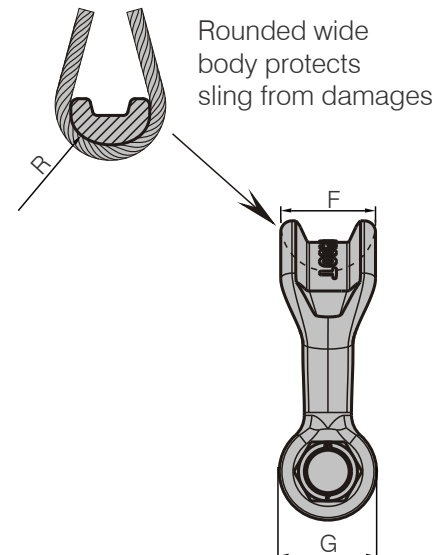
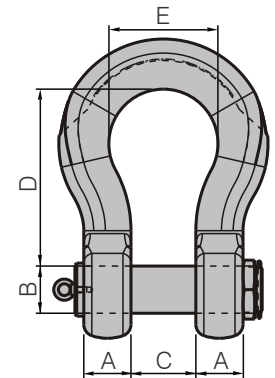

Rounded wide body protects sling from damages



Replacement pins

All sizes of spilt pins and cotter pins are available for replacement.

Commercial type - Stainless and Mild steel

with Screw pin

not for lifting applications

Size	WLL	Dee type		Bow type	
		C	Weight	C	Weight
[mm]	[t]	[mm]	[kgs]	[mm]	[kgs]
4	0.06	16	0.010	16	0.009
5	0.08	19	0.018	19	0.015
6	0.10	25	0.023	25	0.030
10	0.32	38	0.126	38	0.120
12	0.52	51	0.235	51	0.250
16	0.80	64	0.494	64	0.520
20	1.1	76	0.790	76	0.930
22	1.5	89	1.280	89	1.620
25	2.1	100	1.980	100	2.250
28	3.0	115	2.970	115	2.850
32	3.5	128	3.720	127	3.720

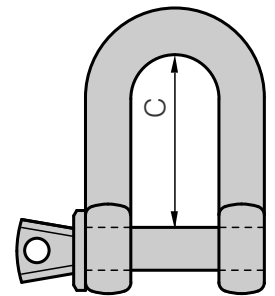
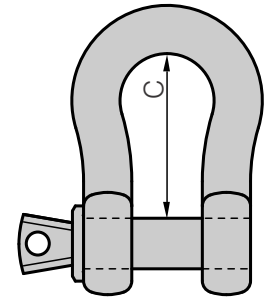

Large dee type

with Screw pin

not for lifting applications

Size	WLL	C	Pin diameter	Weight
[mm]	[t]	[mm]	[mm]	[mm]
6	0.15	29	10	0.10
10	0.45	41	12	0.18
12	0.75	54	16	0.33
16	1.25	70	20	0.63
20	2.00	86	22	0.98
22	2.75	98	25	1.50
25	3.75	108	28	2.18
28	4.75	124	32	3.02
32	5.75	137	35	4.05
38	8.50	168	44	6.40
45	11.50	206	51	10.30
50	15.00	238	57	19.10

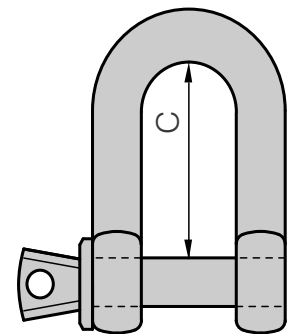



General

- a) Shackles should be inspected before use to ensure that:
 - the body and pin of the shackle are both identifiable as being of the same size, type and make
 - all markings are readable
 - the threads of the pin and the body are undamaged
 - the body and the pin are not distorted
 - the body and the pin are not unduly worn
 - the body and the pin are free from nicks, gouges, cracks and corrosion
- b) Ensure, where appropriate, that the pin is correctly screwed into the shackle eye. i.e. tighten finger tight, then lock using a small tommy bar or suitable tool so that the collar of the pin is seated on the shackle eye. Ensure that the pin is of the correct length so that it penetrates the full depth of the screwed eye and allows the collar of the pin to bed on the surface of the drilled eye.
- c) Incorrect seating of the pin may be due to a bent pin, thread fittings too tightly or misalignment of the pin holes. Do not use the shackle under these circumstances.
- d) Never replace a shackle pin except with one of the same size type and make as it may not be suitable for the loads imposed.

Usage

- a) Select the correct type of shackle for a particular application.
- b) Shackles should not be used in a manner that imposes a side loading unless specifically permitted by the manufacturer. This means that the shackle body should take the load along the axis of its centreline.

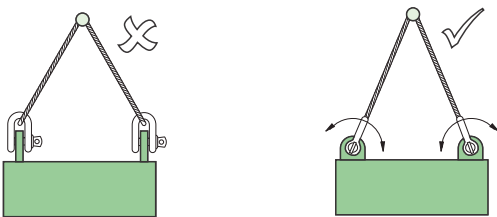

- c) When using shackles in conjunction with multi-leg slings, due consideration should be given to the effect of the angle between the legs of the sling. As the angle increases so does the load in the sling leg and consequently in any shackle attached to the leg.

- c) When a shackle is used to connect two slings to the hook of a lifting machine. It should be a Bow type shackle assembled with the slings in the shackle bod and the hook engaged with the shackle pin.
- d) To avoid eccentric loading of the shackle a loose spacer may be used on either end of the pin. do not reduce the width between the shackle jaws by welding washers or spacers to the inside faces of the eye, this will adversely affect the properties of the shackle.



- e) Avoid applications where due to movement the shackle pin can roll and possibly unscrew.

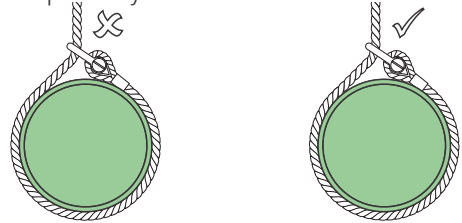

- f) In applications where the shackle is to be left in place for a prolonged period or where maximum pin security is required, use a safety pin.
- g) Avoid applications where the load is unstable



- h) Shackles should not be modified, heat treated, galvanised or subject to any plating process without the approval of the manufacturer.
- i) Shackles should not be immersed in acid solutions or exposed to acid fumes or other chemicals without approval from the manufacturer.

Inspection

- a) Shackles in use should be subject to periodic examination by a competent person at intervals not exceeding three months.

